

SPessori LAVORABILI
THICKNESS ALLOWED

	ANTA-SASH
	58 mm
	64 mm
TELAIO-FRAME	58 mm
	64 mm
	68 mm

SEZIONE VERTICALE
 VERTICAL SECTION

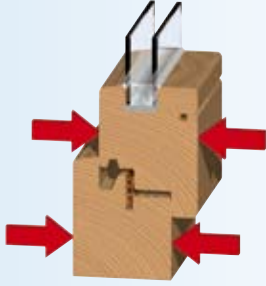
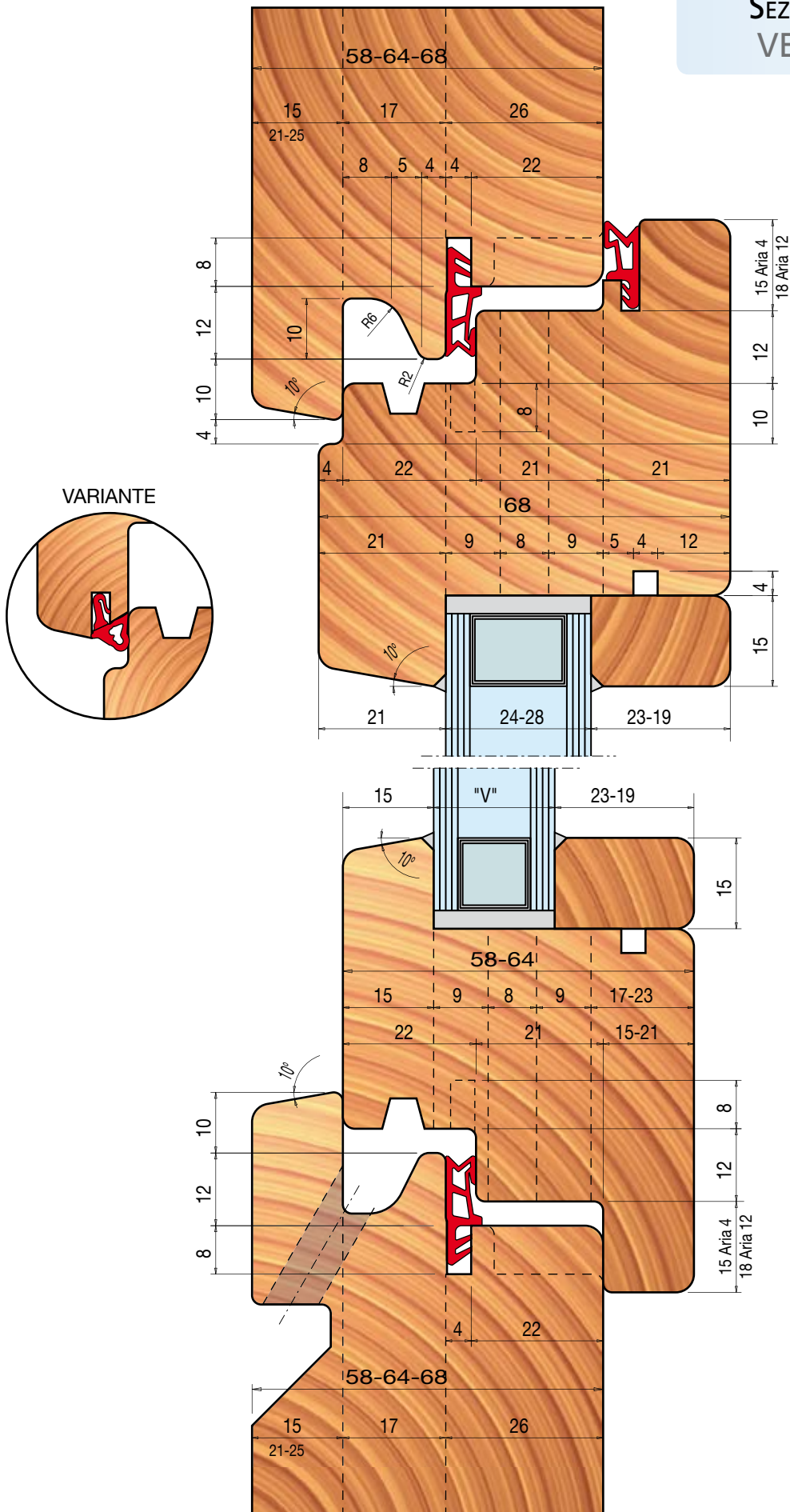

VARIANTE

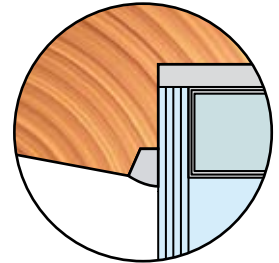

VARIANTE

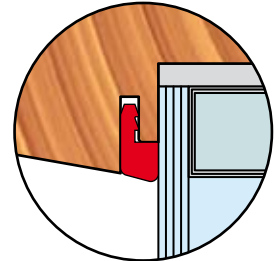

VARIANTE

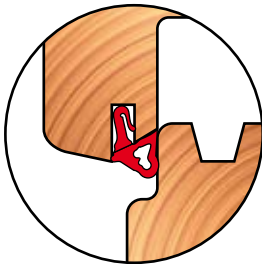

SPESSORE LEGNO WOOD THICKNESS	LISTELLO FISSO FIXED BEAD	REGOLAZIONE VETROCAMERA DOUBLE GLAZING TH. ADJUSTMENT
58	15	20-24
64	15	26-30
64	19	22-26

VARIANTE

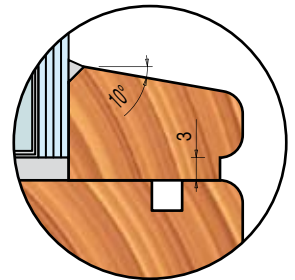

SEZIONE VERTICALE
 VERTICAL SECTION

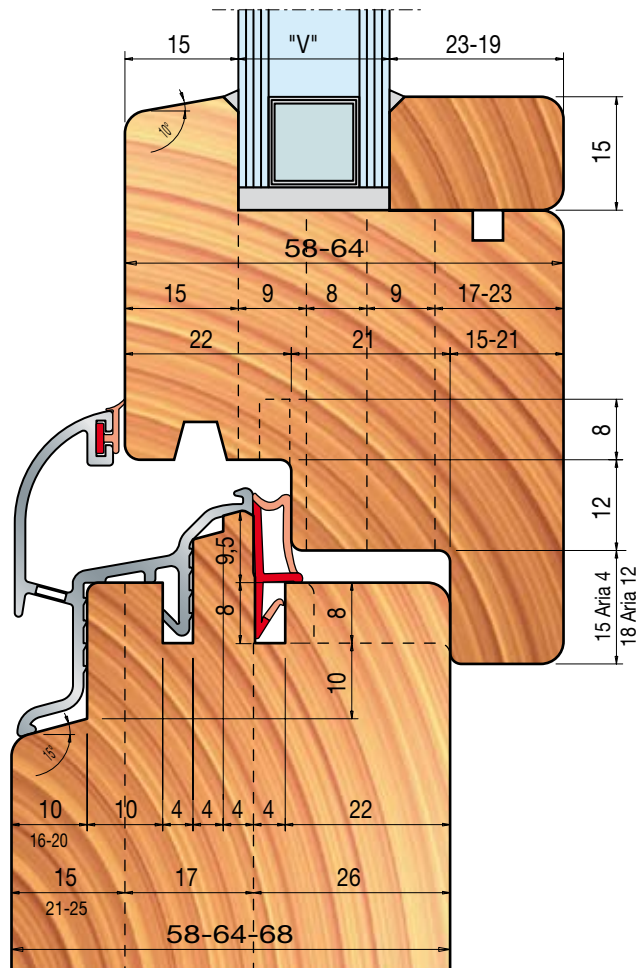
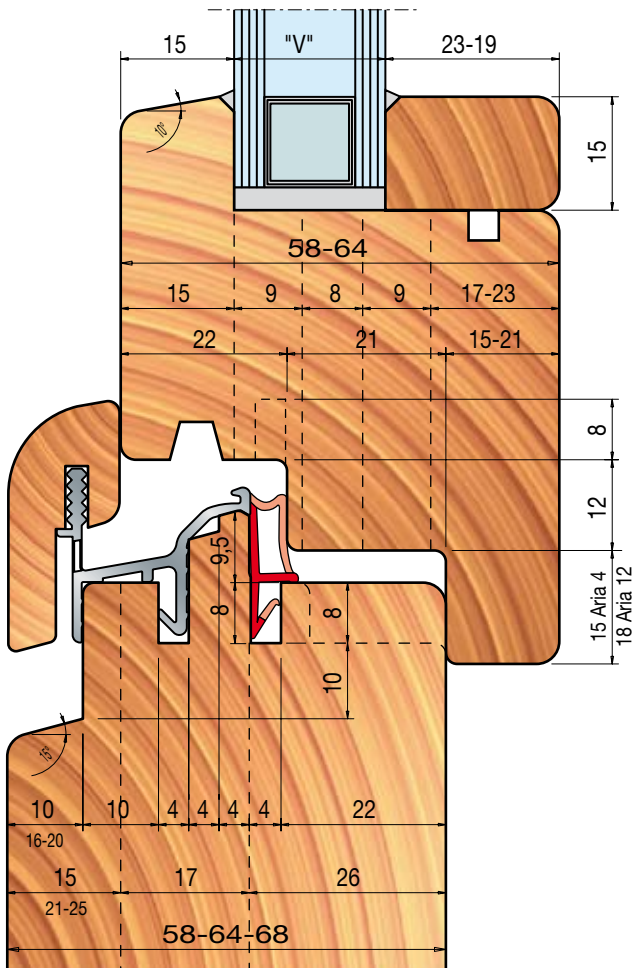
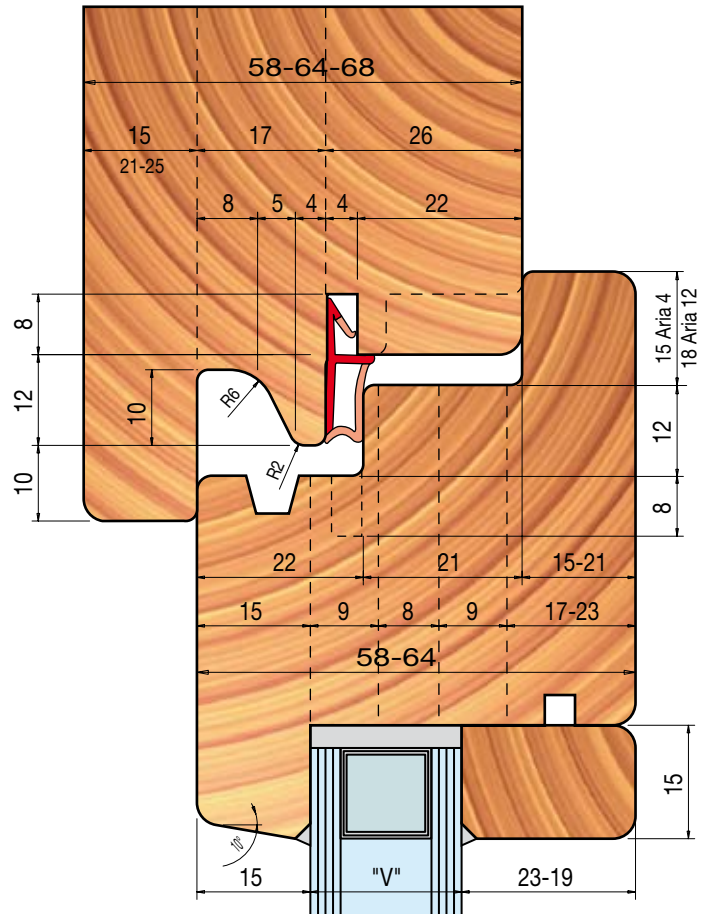

SEZIONE VERTICALE
VERTICAL SECTION

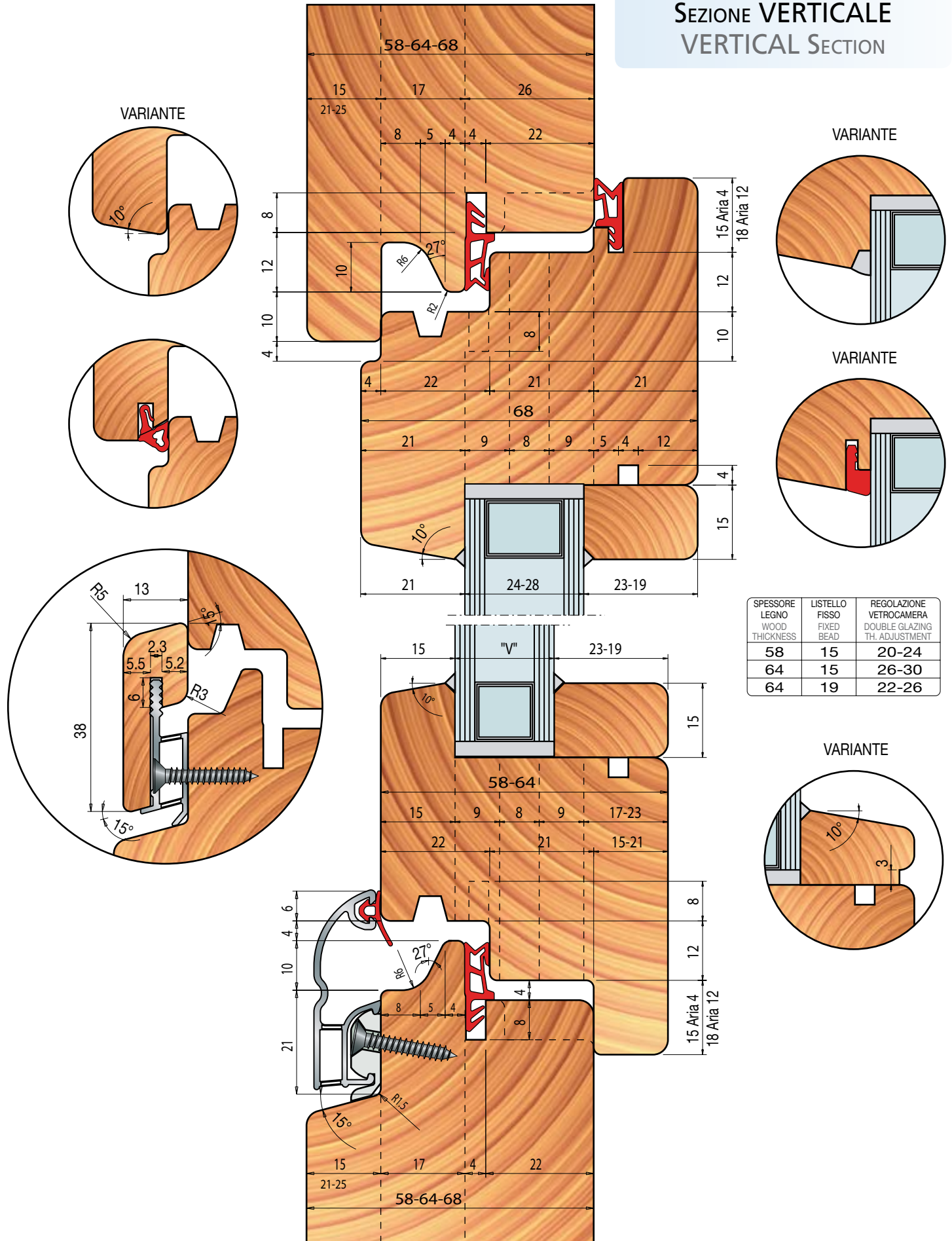

MONTANTINO AGGIUNTO
ADDITIONAL JAMB

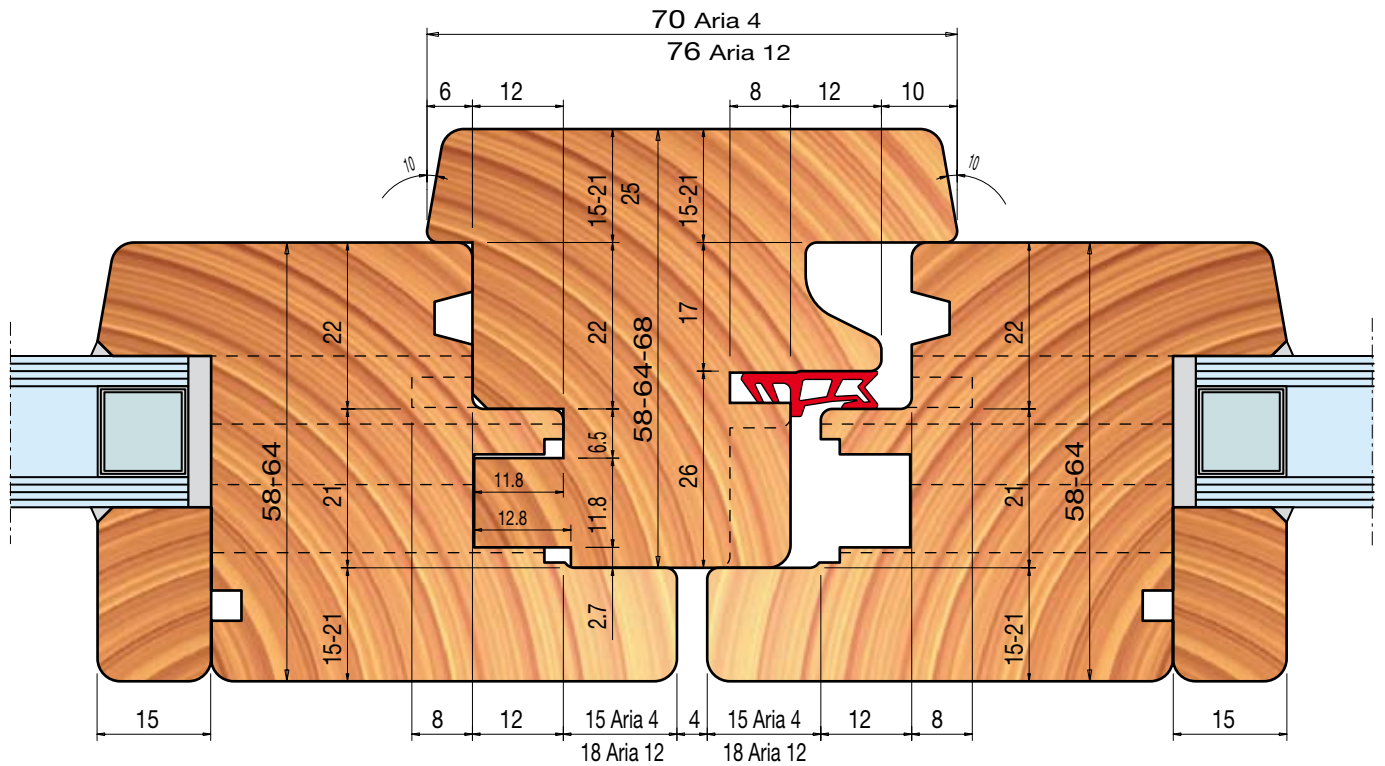

VARIANTE

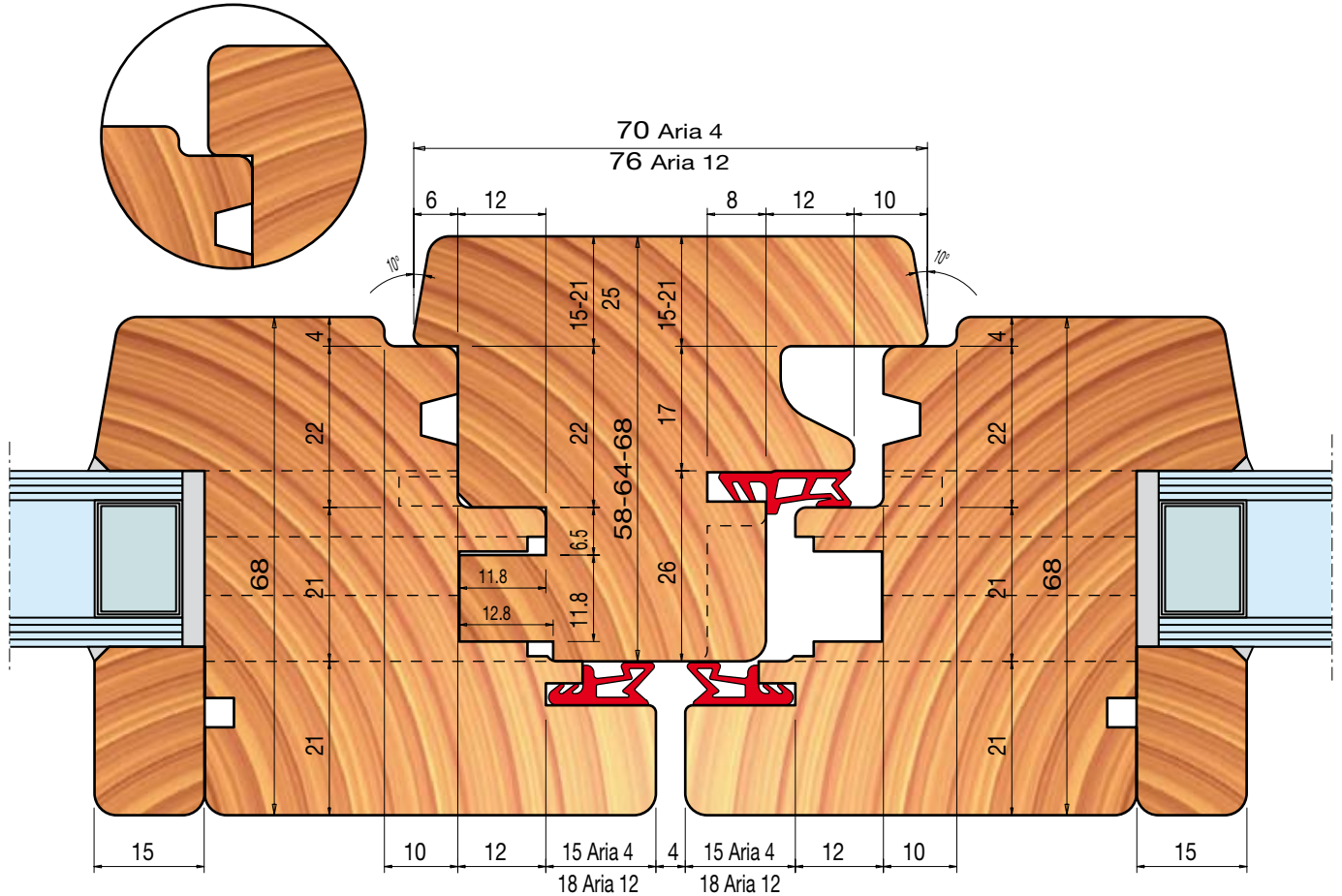

SEZIONE VERTICALE
PORTAFINESTRA
VERTICAL SECTION
FRENCH DOOR

